

5) Travaux dirigés

TD N :1

1. Mettre sur la vue convenable le repère de chaque surface

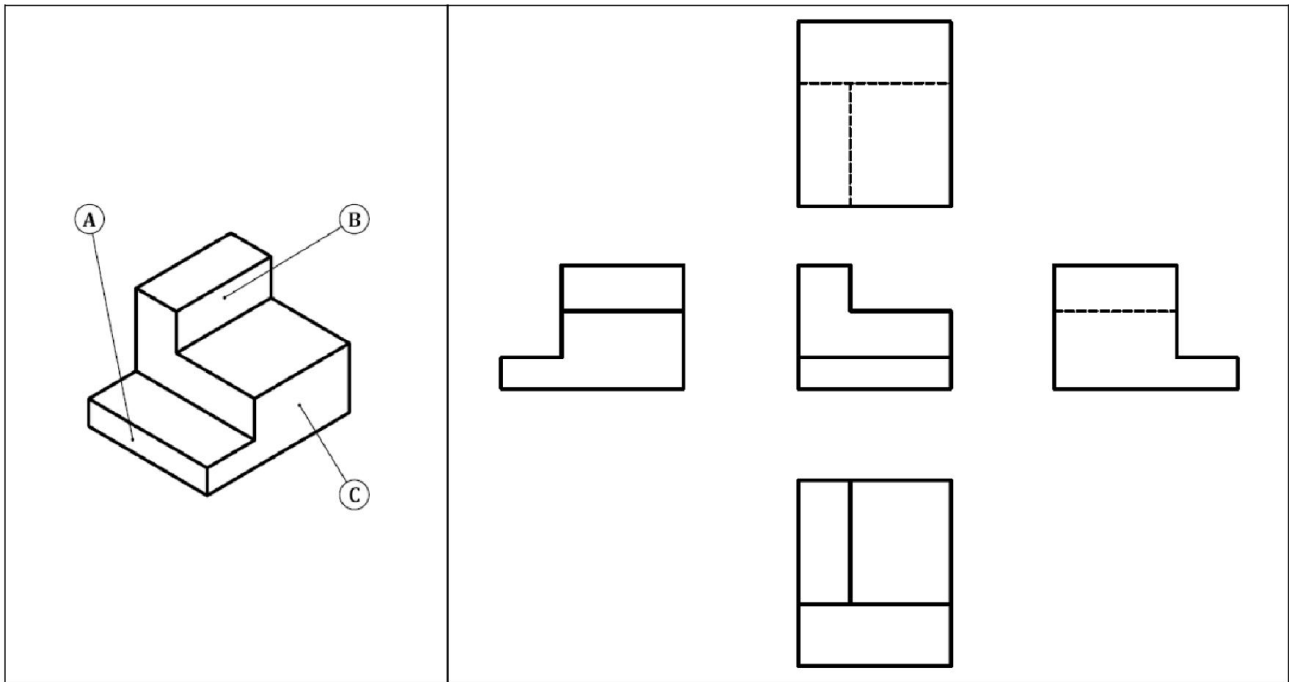

TD N :2

Indiquer sur le dessin en perspective par une flèche légendée les directions d'observation donnant les vues de droite, de gauche et de dessus.

Indiquer le numéro de chacune des Vues suivantes:

- Vue de Face
- Vue de Droite
- Vue de gauche
- Vue de dessus.

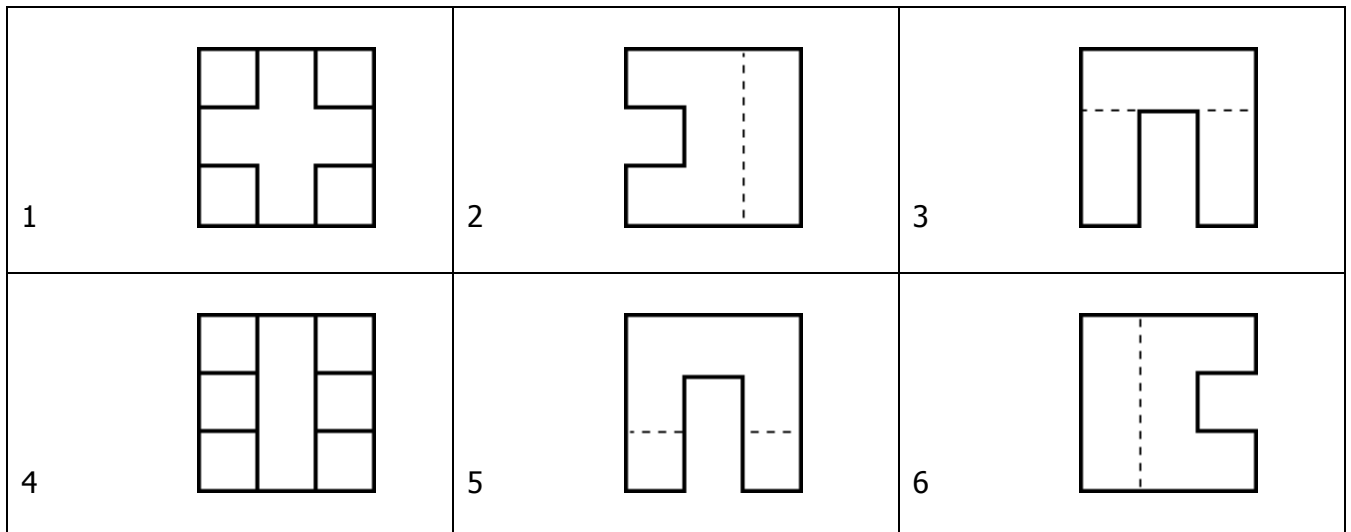
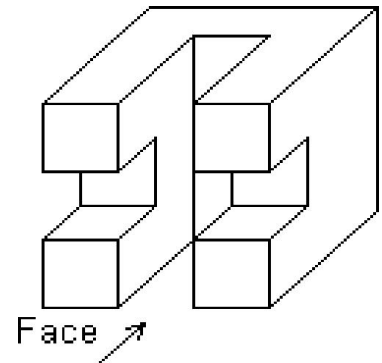

TD N :3

Indiquer le numéro de chacune des Vues suivantes:

- Vue de Face
- Vue de Droite
- Vue de gauche
- Vue de dessus.

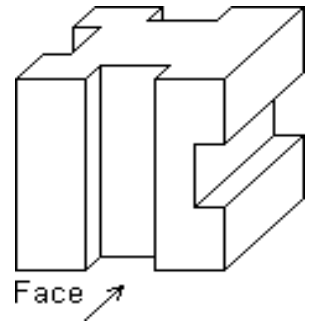

1		2		3	
4		5		6	

TD N :4

Indiquer le numéro de chacune des Vues suivantes:

- Vue de Face
- Vue de Droite
- Vue de gauche
- Vue de dessus.

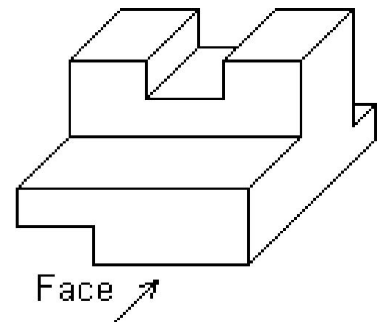

1		2		3	
4		5		6	

TD N :5

Indiquer le numéro de chacune des Vues suivantes:

- Vue de Face
- Vue de Droite
- Vue de gauche
- Vue de dessus.

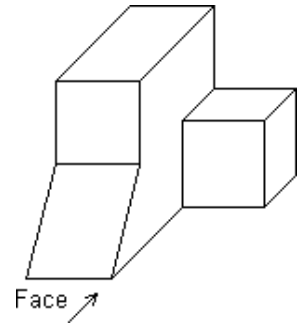

<p>1</p>	<p>2</p>	<p>3</p>
<p>4</p>	<p>5</p>	<p>6</p>

TD N: 6

Compléter la vue de face, la vue de droite et la vue de dessus.

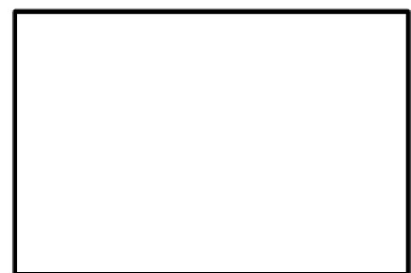
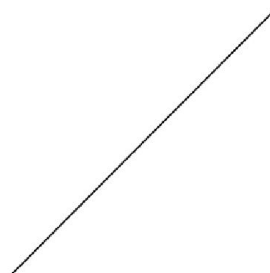
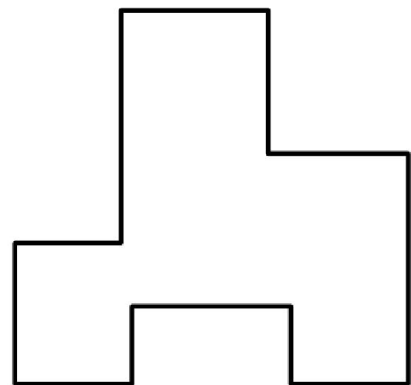
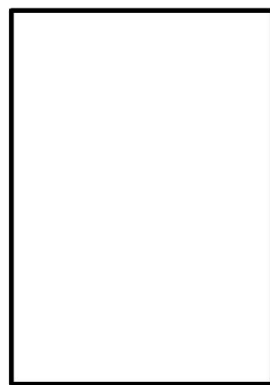
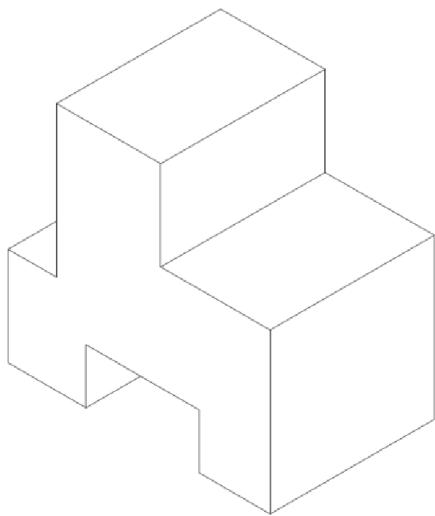

- DN: 7
compléter les vues

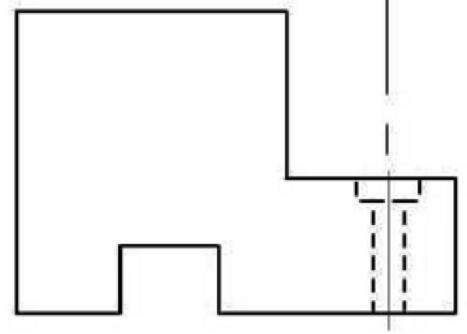
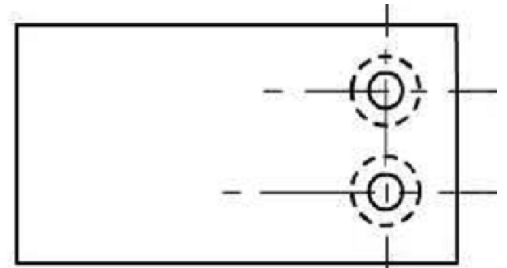
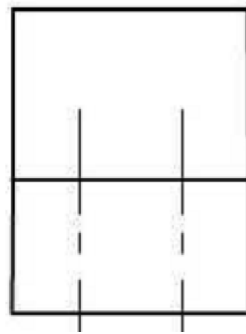
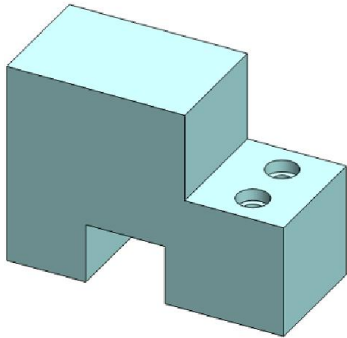

- DN: 8
compléter les 3 vues

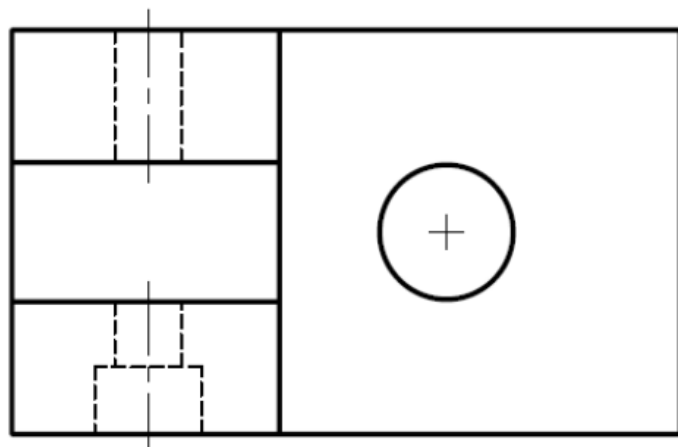
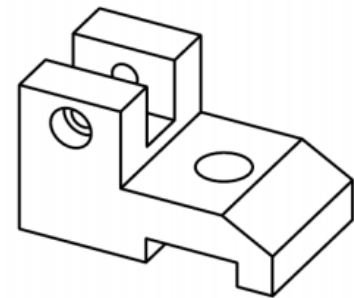
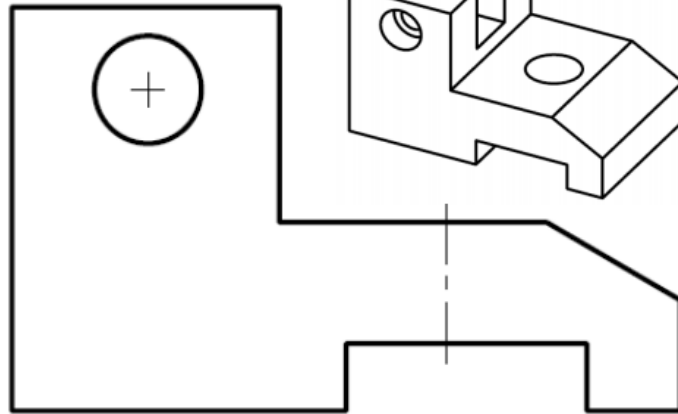
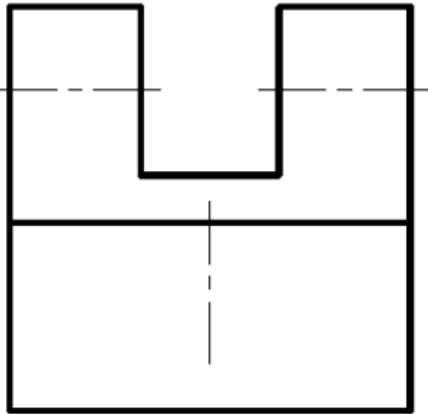

TD N: 9

compléter les 3 vues

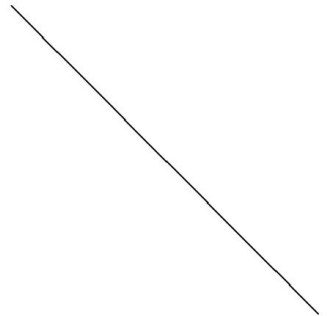
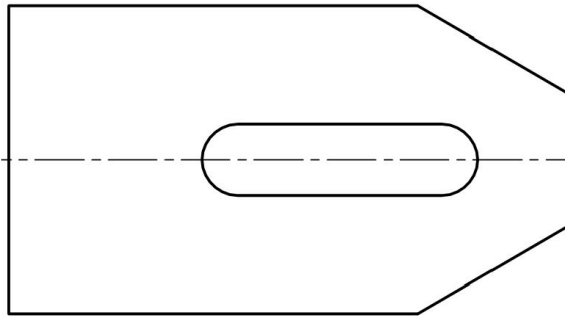
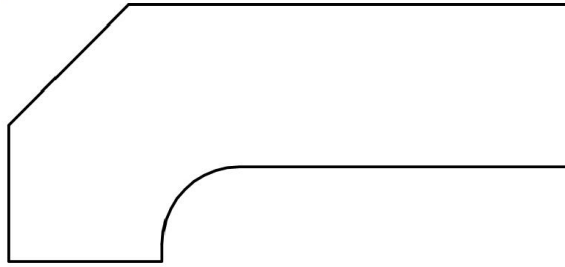
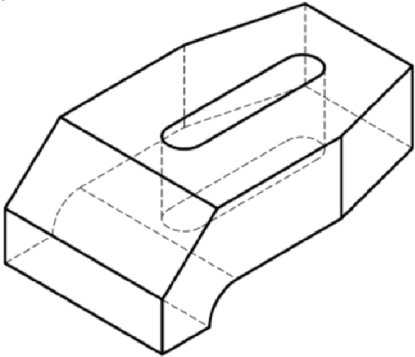

▪ TD N: 10

compléter les 3 vues des deux pieces suivantes:

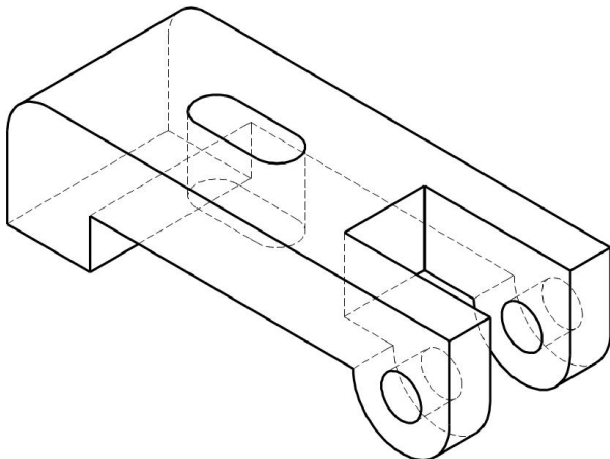
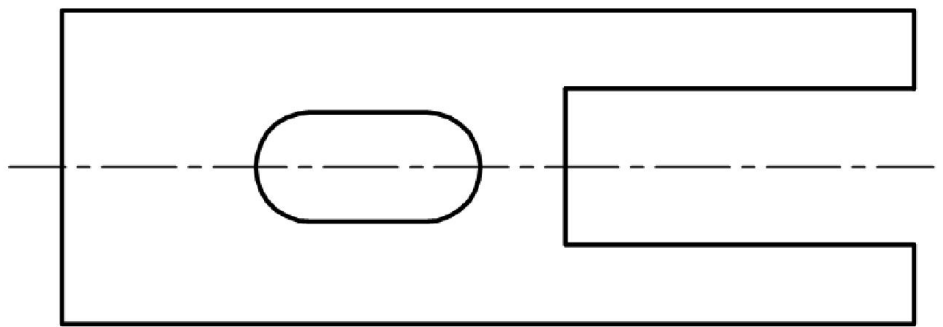
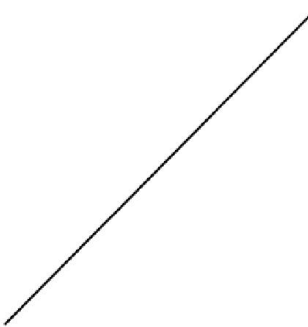
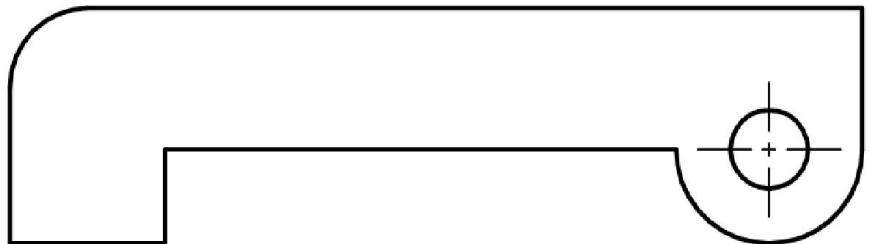

▪ TD N:11

Compléter les vues suivantes

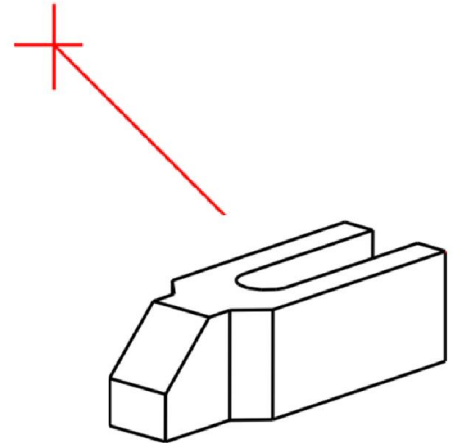
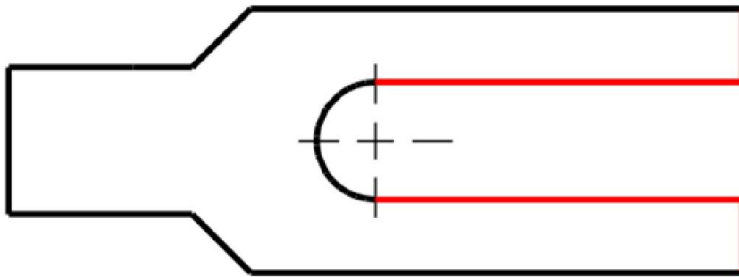
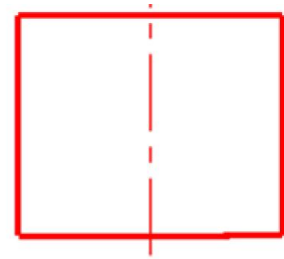

▪ TD N:12

Compléter les vues suivantes

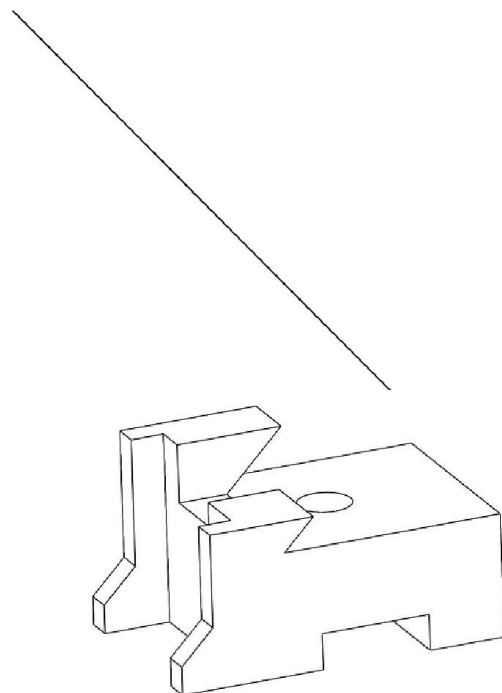
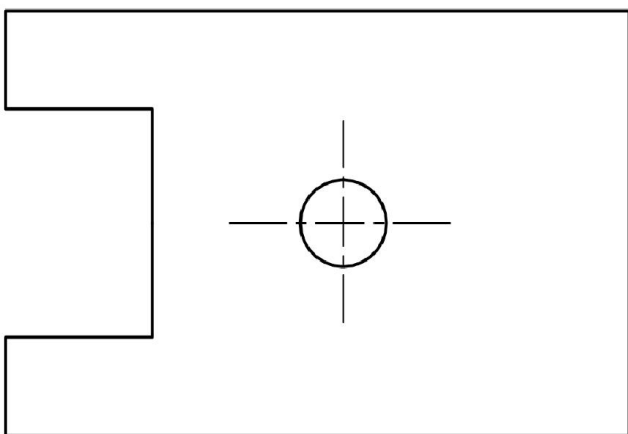
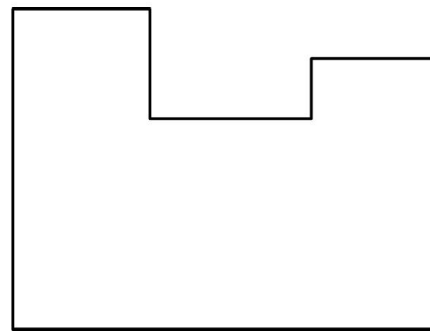
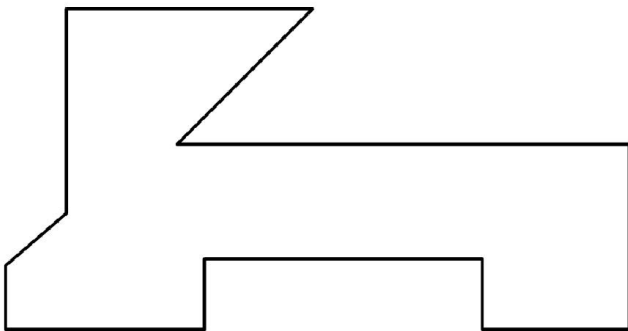

TD N: 13

Compléter les vues des pièces suivantes

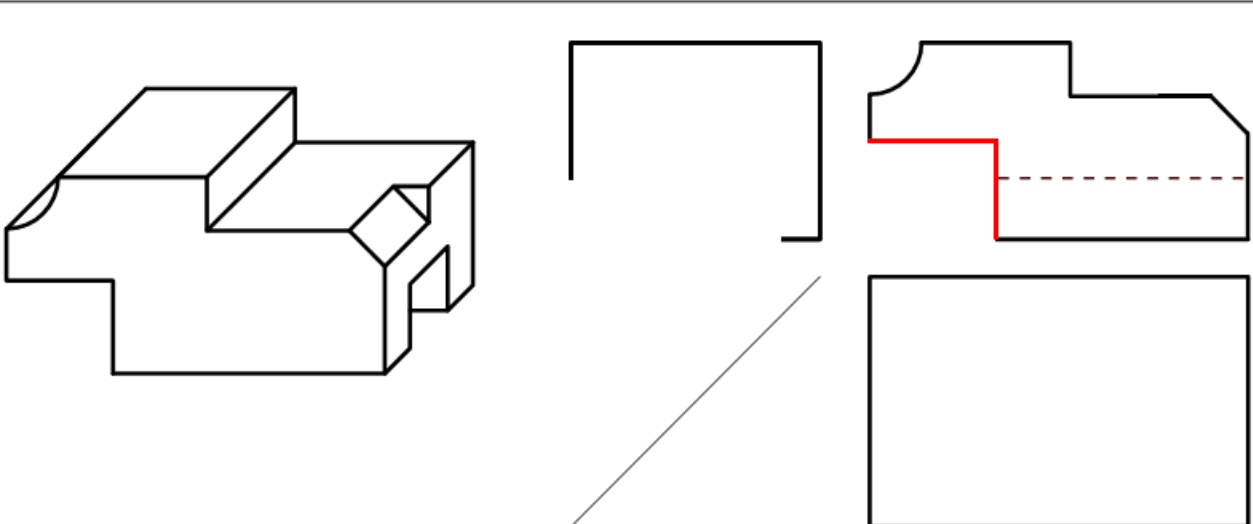
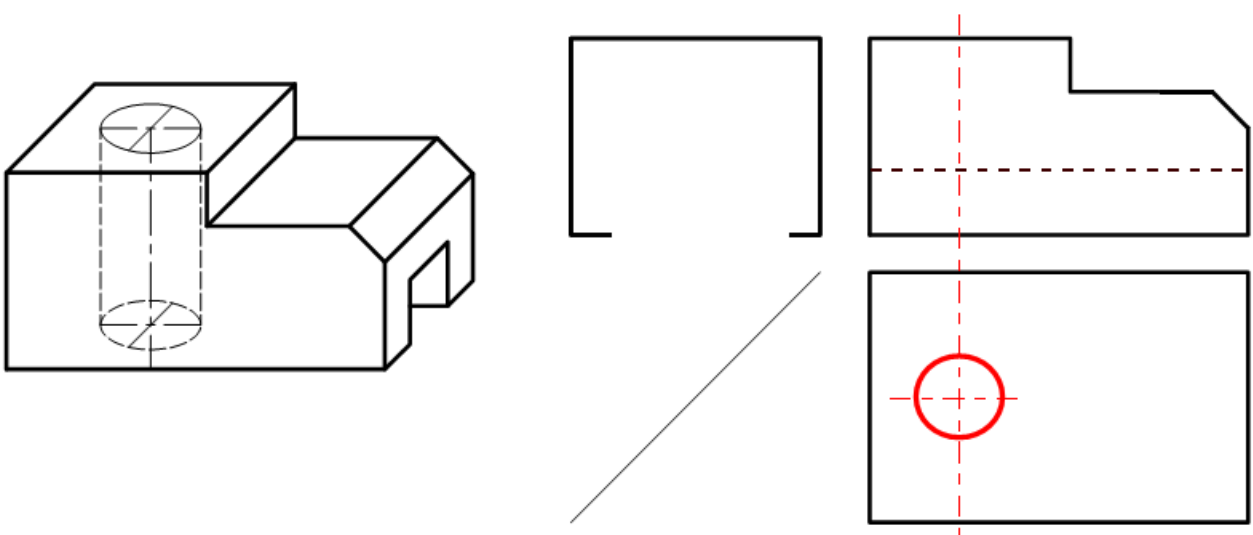
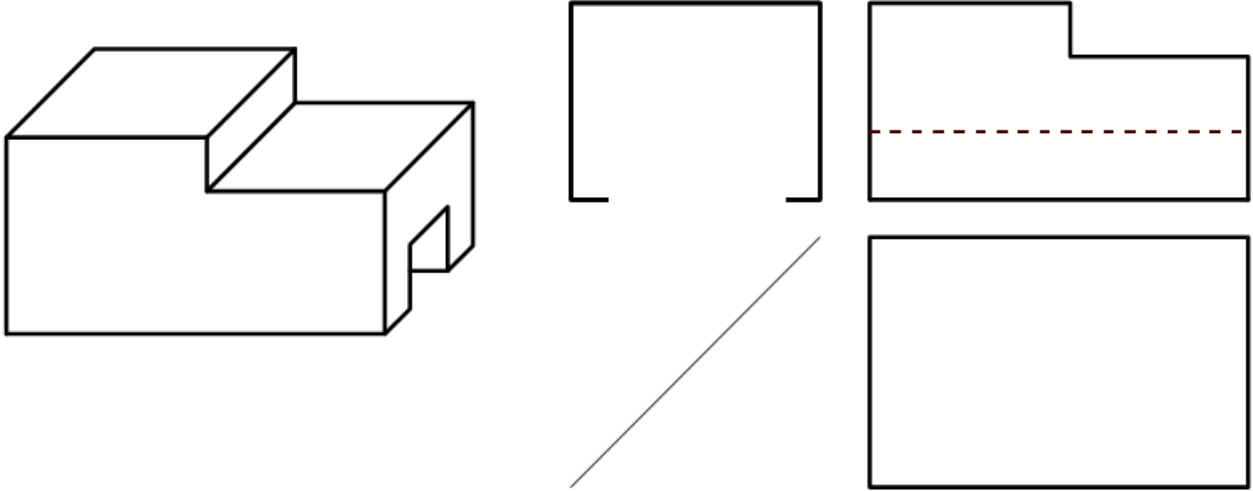

TD N: 14

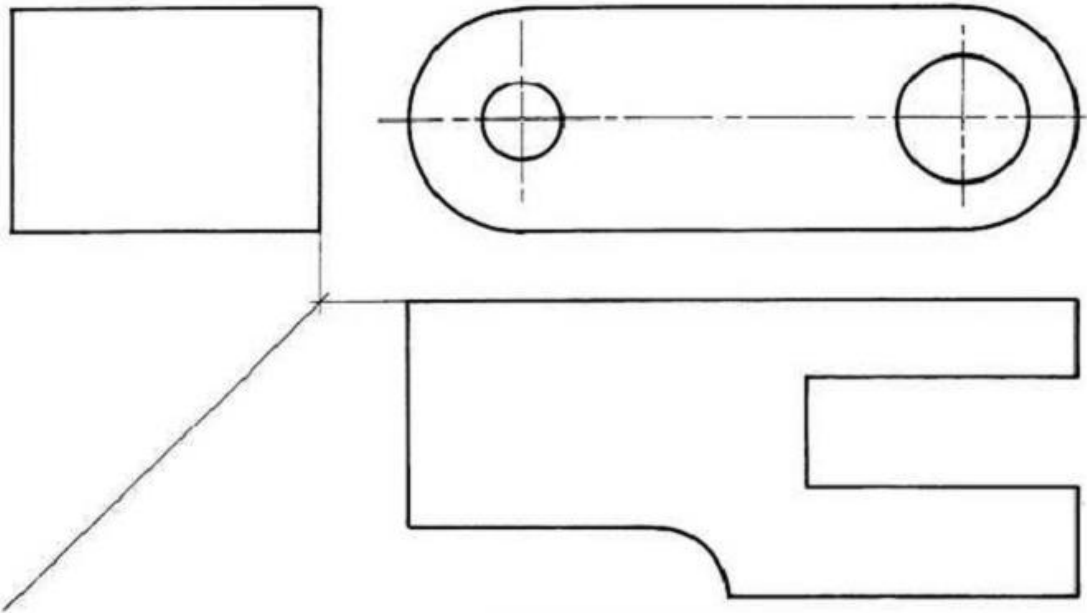

- 1) Esquisser les détails sur les trois vues.
- 2) Faire la mise au net.

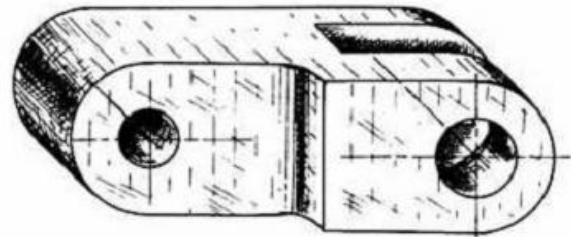

- 1) Esquisser le rectangle capable de la vue de droite.
- 2) Esquisser les détails sur toutes les vues.
- 3) Faire la mise au net.
- 4) Repasser en couleur l'arête repérée sur la perspective.

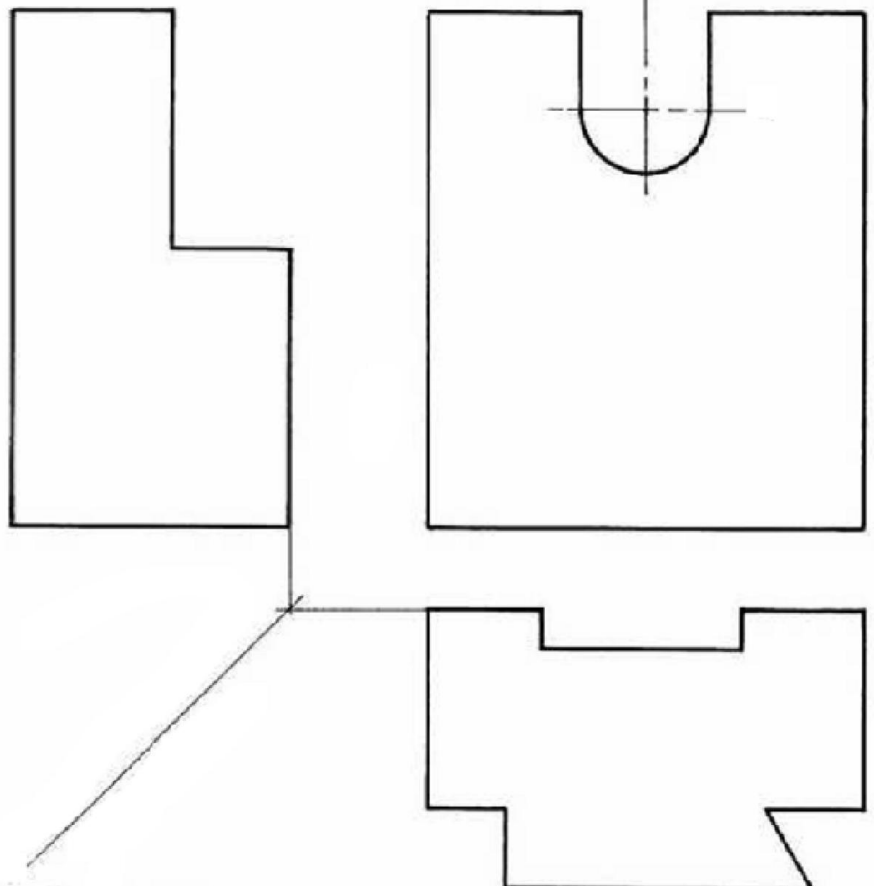
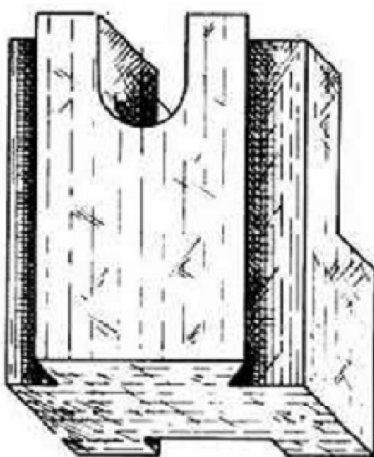

- 1) Esquisser le rectangle capable de la vue de droite.
- 2) Esquisser les différents détails sur les trois vues.
- 3) Faire la mise au net.
- 4) Repasser en couleur les arêtes repérées sur la perspective.

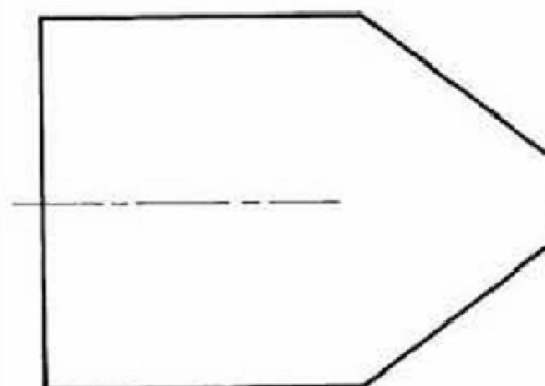
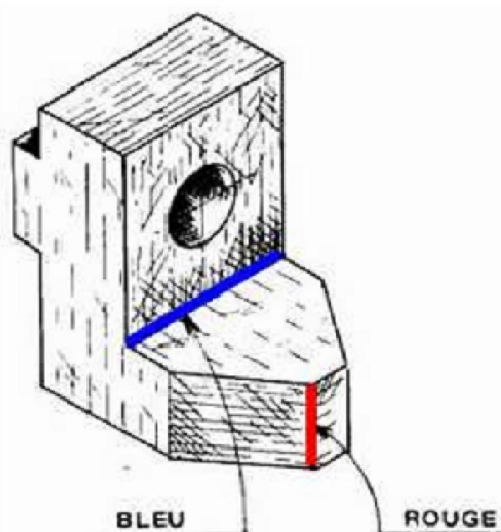
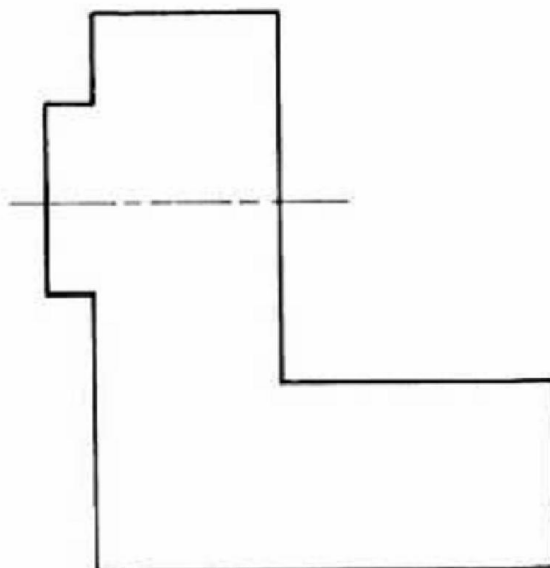
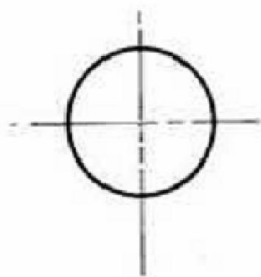

TD N: 15

Compléter les vues incomplètes

